

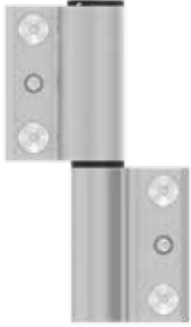





Table des symboles | Icon index

010

D	**
I	

  **CHARNIÈRE 2 LAMES**
DOUBLE FLAG HINGE



  



 12

P010

D	**
I	

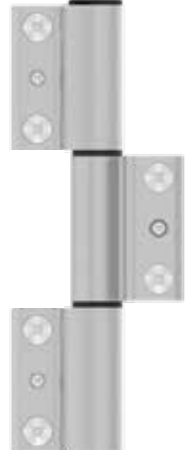
 **CHARNIÈRE 3 LAMES**
TRIPLE FLAG HINGE









  

 12

STC-MC-0011  **KIT DE RÉGLAGE VERTICAL**
VERTICAL ADJUSTMENT KIT



 20

-  Finition anodisé
Anodized finish
-  Finition spéciale
Special finish
-  Finition laqué blanc / noir
Lacquered finish black / white
-  Produit valable seulement pour ouvertures à droite
Suitable for right opening doors only
-  Produit valable seulement pour ouvertures à gauche
Suitable for left opening doors only
-  Produit valable pour ouverture à droite ou à gauche
Suitable for both left and right opening doors
-  Produit pré-monté à droite et interchangeable à gauche
Product pre-assembled for right opening, interchangeable to left opening
- | |
|-----|
| 010 |
|-----|

 Racine de la référence du produit
Root product reference
- | |
|---|
| D |
| I |

 Sens de l'ouverture du produit (droite ou gauche)
Handedness (left or right)
- | |
|----|
| ** |
|----|

 Produit disponible en différentes finitions
Product available in different finishes
- | |
|---|
| 1 |
|---|

 Unités par boîte
Units per case



www.stac.es

Scanner le code QR dans votre smartphone pour accéder directement au produit

Scan the QR code with your smartphone to go directly to the product page



ACRUX

DOOR HINGE | CHARNIÈRE DE PORTE



ACRUX

STAC enrichit sa vaste gamme de charnières pour portes de sécurité de Gorge Européenne avec la nouvelle charnière ACRUX. Ce produit innovant apporte une solution solide et robuste sur le marché exigeant de la fermeture.

STAC has added the new ACRUX hinge to their existing wide range of hinges for Eurogroove door systems. This new product offers a solid and robust solution for the demanding market of door hardware.

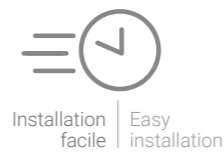

E 1:1

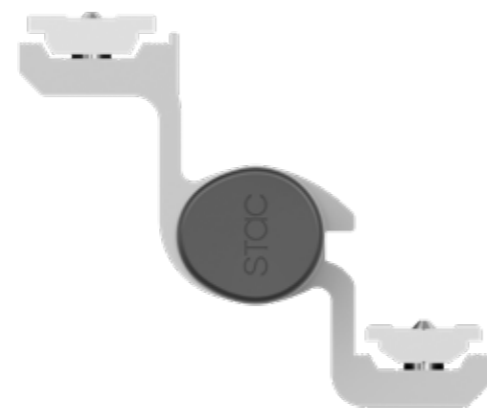

Montage facile

Les systèmes en aluminium se caractérisent par la facilité et la rapidité du montage. La charnière est installée sur des contre-plaques cannelées. Le boulon est tout spécialement conçu pour faciliter son adaptation et insertion dans la douille du battant du vantail.

Règlage

Permet un réglage de $\pm 1,2$ mm dans la chambre du système; la charnière est totalement compatible avec le nouveau régulateur* de hauteur qui permet un réglage en hauteur allant jusqu'à 6 mm.

Simply assembly

The use of aluminium systems stands out thanks to the ease and speed of installation. The hinge is mounted on back-plates which fit in the profile channel. The bolt is specifically designed to facilitate its insertion and fit in the door-side hinge barrel.

Adjustment

Allows regulation of $\pm 1,2$ mm in the chamber of the system and the hinge is fully compatible with the new height adjuster* which allows a height adjustment of up to 6 mm.

Dimensions stylisées

Stylish dimensions

Finition toutes couleurs RAL

Finish in any RAL colour

Possibilité de finition ANODISÉ

ANODIZED finish available



Réglage latéral de $\pm 1,2$ mm

Lateral adjustment $\pm 1,2$ mm

Réglage vertical de ± 3 mm *

Vertical adjustment ± 3 mm *

Matériaux plastiques anti usure

Anti-wear plastic materials

Durabilité

Les composants des surfaces soumises au mouvement sont fabriqués dans des matériaux plastiques techniques à haute résistance. Ceci garanti donc un bon comportement face à la friction, l'usure et la lubrification des surfaces.

Durability

The components of the surfaces subject to relative movement are manufactured from high-resistance technical materials to ensure good resistance to friction, wear and lubrication of surfaces.

Robustesse

Elle supporte des charges de 120 Kg dans sa version à deux ouvrants, et jusqu'à 160 Kg dans sa version à trois ouvrants, ce qui en fait la meilleure charnière dans sa catégorie de fonctionnement, en raison de sa taille et de ses performances.

Sturdiness

The 2-flag version can support loads up to 120 Kg and the 3-flag version up to 160 Kg. This makes it the best hinge available for the range of functionality in terms of size and performance.

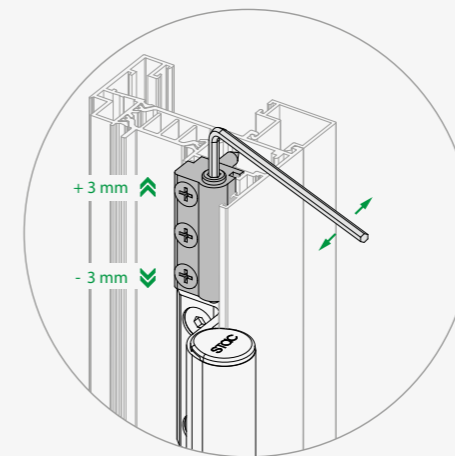

RÉGLAGE VERTICAL*
VERTICAL ADJUSTMENT*

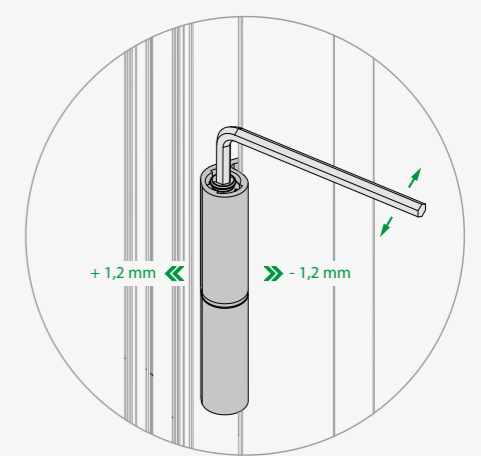

RÉGLAGE LATÉRAL
LATERAL ADJUSTMENT