

# STAC

**General catalogue  
of hardware and  
accessories**

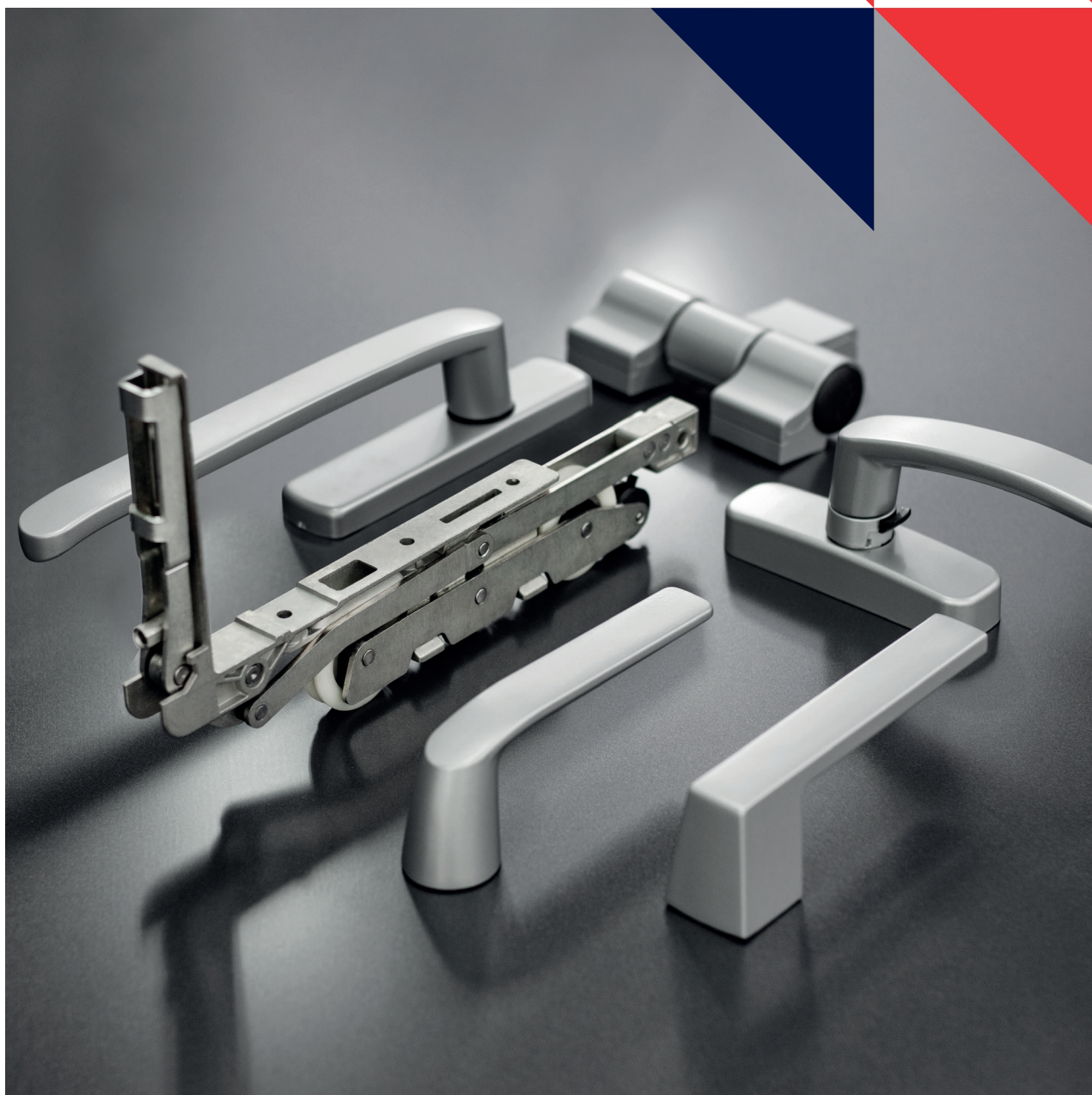

**more than you see**

**Edition** 06.2023

**Reference** MKT-414

**STaC**  
more than you see

## PRODUCT REFERENCE

### » REFERENCE BREAKDOWN

|            |   |    |          |
|------------|---|----|----------|
| <b>023</b> | D | ** | <b>R</b> |
|            | I |    |          |
| A          | B | C  | D        |



#### DESCRIPTION

|          |            |                                      |          |           |                                     |
|----------|------------|--------------------------------------|----------|-----------|-------------------------------------|
| <b>A</b> | <b>023</b> | PRODUCT REFERENCE ROOT               | <b>C</b> | <b>**</b> | AVAILABLE IN DIFFERENT FINISHES     |
|          | <b>D</b>   | PRODUCT VALID FOR RIGHT-HAND OPENING |          | <b>R</b>  | PRODUCT WITH ADJUSTMENT             |
| <b>B</b> | <b>I</b>   | PRODUCT VALID FOR LEFT-HAND OPENING  | <b>D</b> | <b>S</b>  | THE PRODUCT INCLUDES SIRIUS CREMONE |



Other digits may appear larger to complete the product reference.

### » AVAILABLE FINISHES

#### IN STOCK

|  |           |                            |
|--|-----------|----------------------------|
|  | <b>00</b> | PLAIN FINISH OR UNFINISHED |
|  | <b>01</b> | WHITE LACQUER FINISH       |
|  | <b>02</b> | BLACK LACQUER FINISH       |

#### NOT AVAILABLE IN STOCK \*

|  |           |                                      |   |           |                   |
|--|-----------|--------------------------------------|---|-----------|-------------------|
|  | <b>81</b> | NATURAL MATT ANODIZED FINISH         |  | <b>91</b> | SPECIAL FINISH 01 |
|  |           | MATT STAINLESS STEEL ANODIZED FINISH |   | <b>92</b> | SPECIAL FINISH 02 |
|  | <b>94</b> | LIQUID PAINT FINISH                  |   | <b>93</b> | SPECIAL FINISH 03 |

\* Please contact us at [info@stac.es](mailto:info@stac.es) for availability and delivery date.

» MATERIALS

|            |                           |
|------------|---------------------------|
| <b>AL</b>  | ALUMINIUM                 |
| <b>AC</b>  | STEEL                     |
| <b>PA</b>  | POLIAMIDE                 |
| <b>POM</b> | POLYOXYMETHYLENE (ACETAL) |
| <b>PP</b>  | POLYPROPYLENE             |



|            |                                 |
|------------|---------------------------------|
| <b>ZM</b>  | ZAMAK                           |
| <b>INX</b> | STAINLESS STEEL                 |
| <b>PE</b>  | POLYETHYLENE                    |
| <b>PVC</b> | POLYVINYL CHLORIDE              |
| <b>ABS</b> | ACRYLONITRILE BUTADIENE STYRENE |

» TOOLS

|                 |                  |
|-----------------|------------------|
| <b>allen2,5</b> | 2,5 mm ALLEN KEY |
| <b>allen3</b>   | 3 mm ALLEN KEY   |
| <b>allen4</b>   | 4 mm ALLEN KEY   |
| <b>allen5</b>   | 5 mm ALLEN KEY   |
| <b>allen6</b>   | 6 mm ALLEN KEY   |



|               |                                  |
|---------------|----------------------------------|
| <b>TORX30</b> | T30 TORX KEY                     |
| <b>PH2</b>    | REFERENCE WITH PHILLIPS 2 SCREWS |
| <b>7 mm</b>   | REFERENCE WITH 7 mm SPINDLE      |
| <b>8 mm</b>   | REFERENCE WITH 8 mm SPINDLE      |
| <b>10 mm</b>  | REFERENCE WITH 10 mm SPINDLE     |



» PACKING

|  |                 |
|--|-----------------|
|  | UNITS PER BOX   |
|  | METRES PER REEL |

|   |                |
|---|----------------|
|  | UNITS PER TUBE |
|---|----------------|

» BEARING

|   |              |
|---|--------------|
|  | BALL BEARING |
|  | PIN BEARING  |

|   |                     |
|---|---------------------|
|  | DOUBLE BALL BEARING |
|  | SINGLE BEARING      |



» FRAME TYPE

|  |                   |
|--|-------------------|
|  | EURO GROOVE FRAME |
|--|-------------------|





|   |            |
|---|------------|
|  | FLAT FRAME |
|---|------------|



» **PRODUCT HAND**

|  |   |
|--|---|
|  | PRODUCT VALID FOR RIGHT-HAND OPENING                      |
|  | PRE-MOUNTED FOR RIGHT-HAND & INTERCHANGEABLE TO LEFT-HAND |
|  | AMBIDEXTROUS PRODUCT                                      |



|   |   |
|---|---|
|  | PRODUCT VALID FOR LEFT-HAND OPENING                       |
|  | PRE-MOUNTED FOR LEFT-HAND & INTERCHANGEABLE TO RIGHT-HAND |
|  | AMBIDEXTROUS PRODUCT BUT SUPPLIED UNMOUNTED               |



» **VALID OPENINGS**

|   |   |
|---|---|
|   | SIDE-HUNG OPENING   |
|   | SIDE-HUNG OPENING INTERCHANGEABLE TO TILT & TURN OPENING  |
|   | TILT & TURN OPENING INTERCHANGEABLE TO BOTOM-HUNG OPENING |
|  | TILT & TURN AND SIDE-HUNG OPENING                         |



|   |  |
|---|--|
|  | TILT & TURN OPENING  |
|  | TILT & TURN OPENING INTERCHANGEABLE TO SIDE-HUNG OPENING   |
|  | BOTTOM-HUNG OPENING INTERCHANGEABLE TO TILT & TURN OPENING |

» **GROOVE TYPE**

|  |                |
|--|----------------|
|  | EURO GROOVE    |
|  | CENTRAL GROOVE |

|   |                |
|---|----------------|
|  | 16 GROOVE      |
|  | WITHOUT GROOVE |

» **TILT & TURN WINDOW OPENING**

|  |  |
|--|--|
|  | TILT & TURN WINDOW WITH LOCKING TO FRAME |
|  | TILT-BEFORE-TURN WINDOW                  |

|   |   |
|---|---|
|  | TILT & TURN WINDOW WITH LOCKING TO INVERTER |
|---|---|

» **MICRO VENTILATION**

|  |   |
|--|---|
|  | THE PRODUCT ALLOWS VENTILATION POSITION |
|--|---|

|   |   |
|---|---|
|  | THE PRODUCT DOES NOT ALLOW VENTILATION POSITION |
|---|---|

» **FAST FIXING SYSTEM**

|  |   |
|--|---|
|  | YOU HAVE THE POSSIBILITY TO ORDER THE PRODUCT WITH THE BUILT-IN FAST FIXING SYSTEM. SEE INSTRUCTIONS IN THE CHAPTER "CREMONES AND HANDLES", SECTION "TECHNICAL NOTES". TO ORDER REFERENCES WITH THE FAST SYSTEM, YOU MUST ADD AN « F » BEFORE THE FINISH (ONLY FOR THOSE PRODUCTS WHERE THIS POSSIBILITY IS INDICATED). |
|--|---|

**STaC**

MIDDLE EAST REFERENCES

# HINGES

## ACRUX 2-LEAF

010X \*\*

12



- \*\*
- 
- AL INX
- CE**
- 
- allen3
- allen6
- TORX30

## ACRUX 3-LEAF

P010 D \*\*

6



- \*\*
- 
- ANODIC
- AL INX
- CE**
- 
- allen3
- allen6
- TORX30

## ARIES 2-LEAF

|          |    |
|----------|----|
| 010T2 ** | 40 |
|          | 60 |
|          | 66 |
|          | 80 |
|          | 93 |

2



- \*\*
- 
- ANODIC
- AL INX
- PA POM
- 
- allen6

## TAURUS

A011X \*\*

12



- \*\*
- 
- AL INX
- POM
- CE**
- 
- allen3
- TORX30

## HERCULES

C0170 \*\*

40



- \*\*
- 
- ANODIC
- AL INX
- PA
- CE**
- 
- allen2,5
- PH2

## CARINA

B023X \*\*

30



- \*\*
- 
- AL INX
- PA
- CE**
- 
- PH2



## HINGES

### CARINA 3<sup>RD</sup> SASH

014X \*\*

30



## HANDLE & CREMONES

### SIRIUS OFFSET HANDLE

S1161 \*\*

20



### DELTA CREMONE

7003 \*\*

20



### SIRIUS CREMONE

P0794 \*\*

20



### LEO CREMONE

P0760 \*\*

25



# HANDLES & CREMONES

## DELTA CREMONE

7004 \*\*

20



- \*\*
- 
- AL ZM
- PA INX
- 
- FAST
- allen4

## SIRIUS CREMONE

A0790 \*\*

20



- \*\*
- 
- ANODIC
- AL ZM
- PA INX
- 
- FAST
- allen4

## LEO CREMONE

S0710 \*\*

25



- \*\*
- 
- AL ZM
- PA INX
- 
- FAST
- allen4

## DELTA HANDLE

7008 \*\*

25



- \*\*
- 
- AL ZM
- POM AC
- 
- 7 mm
- allen2,5
- PH2

## SIRIUS HANDLE

A0775 \*\*

25



- \*\*
- 
- AL ZM
- POM AC
- 
- 7 mm
- allen2,5
- PH2

## SIRIUS OFFSET HANDLE

B0777 \*\*

25



- \*\*
- 
- AL ZM
- POM AC
- 7 mm
- allen2,5
- PH2

# HANDLES & CREMONES

## DELTA OFFSET HANDLE

7016 \*\*

15



- \*\*
- 
- AL ZM
- POM AC
- 7 mm
- allen2,5
- PH2

## POLARIS XXL HANDLE

S5777 \*\*

20



- \*\*
- 
- AL ZM
- POM AC
- 
- 7 mm
- allen2,5
- PH2

## POLARIS BLOCK HANDLE

S5779 \*\*

20



- \*\*
- 
- AL ZM
- POM AC
- 
- 7 mm
- allen2,5
- PH2

## LEO BLOCK CREMONE

0730 \*\*

20



- \*\*
- 
- AL ZM
- PA INX
- 
- FAST
- allen4

## SIRIUS BLOCK CREMONE

A0793 \*\*

20



- \*\*
- 
- AL ZM
- PA INX
- 
- FAST
- allen4

## HYDRA CREMONE

A0750L \*\*

15



- \*\*
- 
- AL ZM
- PA INX
- 
- PH2

## HANDLES & CREMONES

### SIRIUS DETACHABLE HANDLE

0507167 \*\*

20



### SIRIUS DETACHABLE CREMONE

A07901 \*\*

20



## DOOR HANDLES

### DELTA DOOR HANDLE

7005 \*\*

20

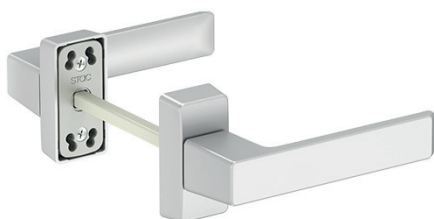

### SIRIUS DOOR HANDLE

A05082 \*\*

20



### INDO DOOR HANDLE

A05086 \*\*

12



### SIRIUS CYLINDER COVER PLATE

0508029 \*\*

75



## DOOR HANDLES

### DELTA CYLINDER COVER PLATE

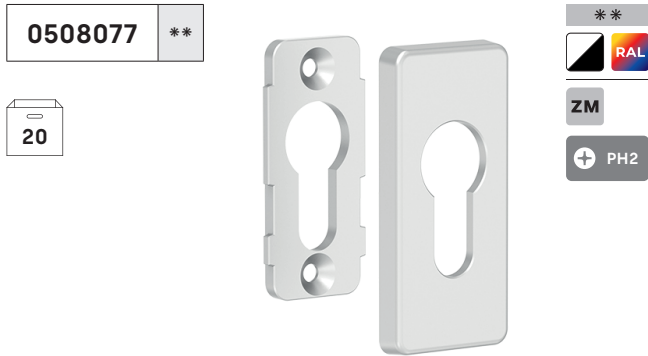

## ACCESSORIES

### Ø6 SIDE-HUNG KIT WITH ADJUSTMENT



### 13.5~16.8 PASSIVE SASH KIT WITH ADJUSTMENT



### OUTWARD OPENING KIT

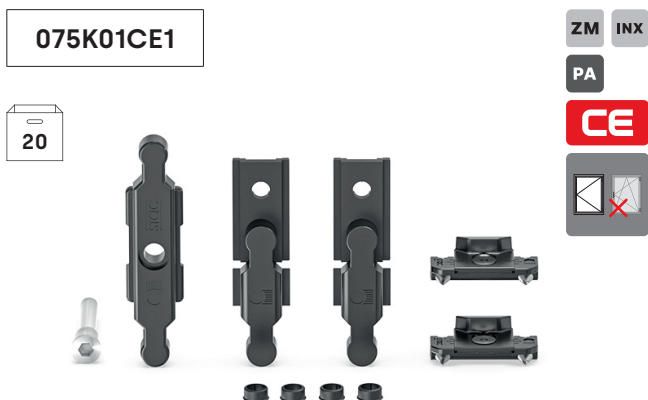

### SUPPLEMENTARY LOCKING POINT



# ACCESSORIES

## SUPPLEMENTARY LOCKING POINT KIT



## TOP-HUNG WINDOW LOCKING POINT KIT



## TOP-HUNG WINDOW TRANSMISSION KIT



## TILT & TURN WINDOW TRANSMISSION COVER



## ONE-WAY GEARBOX (backset 7 millimetres)



## ONE-WAY GEARBOX (backset 33.5 millimetres)



## ACCESSORIES

### LATCH KIT

0710621

ZM INX



100



### HORIZONTAL CORNER DRIVE

113420

ZM INX



20



### PVC TRANSMISSION ROD

059238



PVC

250

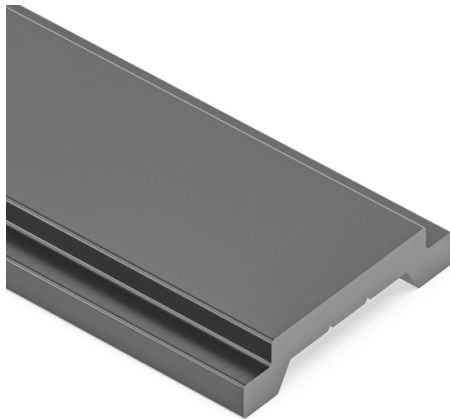

## TILT & TURN OPENING

### LOCKING TO THE INVERTER KIT WITH SIRIUS CREMONE AND CLASSIC HINGES

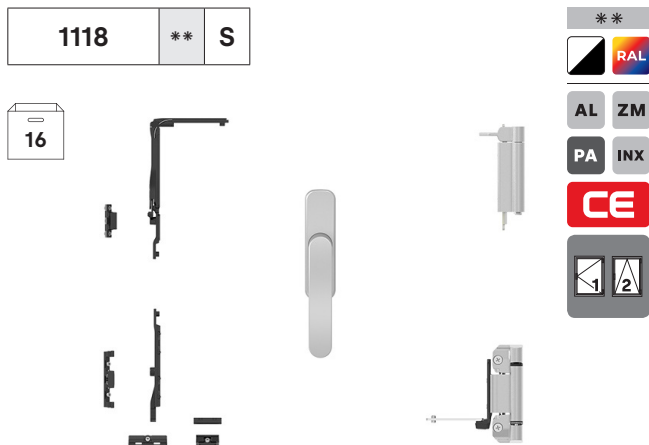

### LOCKING TO THE INVERTER KIT WITH SIRIUS CREMONE AND CLX HINGES

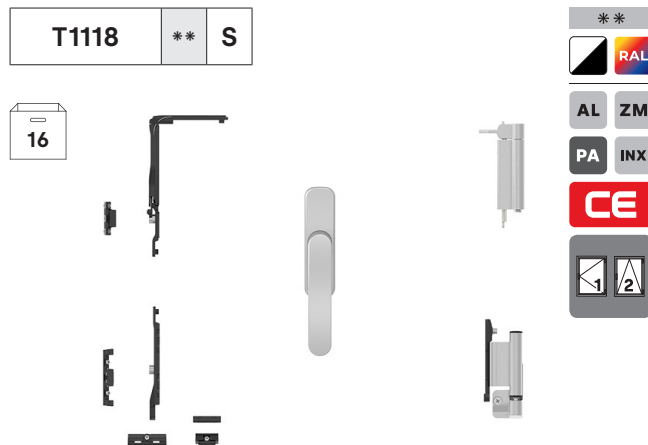

### SUPPLEMENTARY CORNER DRIVE

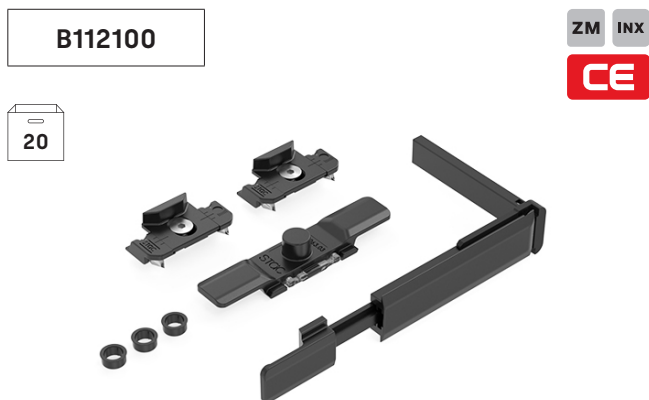

### SUPPLEMENTARY FRICTION STAY



### CLASSIC HINGES FOR PASSIVE SASH



### CLX HINGES FOR PASSIVE SASH





## PASSIVE SASH

### LONG SHOOTBOLT LEVER KIT

A112710

40



### LONG SHOOTBOLT LEVER KIT WITH LOCKING POINT

A112720

40



### DENEBO FLUSH BOLTS

0524

|    |    |
|----|----|
| 01 |    |
| 02 | ** |
| 03 |    |
| 04 |    |

15



### DUST COVER

05241001

500

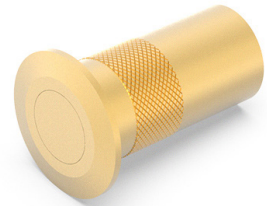

### DENEBO UPPER LOCKING POINT

0524020

ZM

20



### SASH RETAINER CLIP KIT

0507047

50



## TOP-HUNG OPENING

### PLEXUS TOP-HUNG WINDOW HANDLE

1551 \*\*

1



### SIRIUS PRESSURE HANDLE

1508 \*\*

30



### CURTAIN WALL FRICTION STAY (L = 455)

A18011

20



INX

### CURTAIN WALL FRICTION STAY (L = 705)

A18012

20



INX

### CURTAIN WALL FRICTION STAY (L = 555)

A18017

20



INX

### CURTAIN WALL FRICTION STAY (L = 600)

A18018

20



INX

## TOP-HUNG OPENING

### STAINLESS STEEL LIMITING FRICTION STAY

18010

INX

25



### FINGER CATCH

1560

50

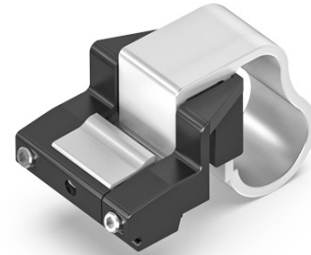

\*\*



AL ZM

INX

### PEGASO PRESSURE FASTENER

100002

\*\*

25



\*\*



ZM INX

PA

### SHORT LIMITING FRICTION STAY

A130100

40



ZM INX

PA

# SLIDING WINDOW

## TITAN RECESSED HANDLE

034000 \*\*

40



\*\*  
RAL  
AL ZM  
PA INX

## TITAN FINGER PULL

0342000 \*\*

40



\*\*  
RAL  
ZM PA

## TITAN BLOCK RECESSED HANDLE

034100 \*\*

40



\*\*  
RAL  
AL ZM  
PA INX

## TITAN PULL HANDLE FOR RECESSED HANDLE

034300 \*\*

15



\*\*  
RAL  
AL ZM  
PA INX

## TITAN BASIC PULL HANDLE

034500 \*\*

15



\*\*  
RAL  
AL ZM  
INX

## FENIX MANUAL RECESSED HANDLE

032000 \*\* C

40



\*\*  
RAL  
AL ZM  
PA INX

# SLIDING WINDOW

## FENIX FINGER PULL

032100 \*\*

50



\*\*  
RAL  
ZM PA

## FENIX PULL HANDLE

0320 \*\*

50



\*\*  
RAL  
AL INX

## FENIX MINI RECESSED HANDLE

B03300 \*\*

40



\*\*  
RAL  
AL ZM  
PA INX

## FENIX MINI PULL HANDLE

0503087 \*\*

40



\*\*  
RAL  
AL INX

## DRACO MAX AUTOMATIC RECESSED HANDLE

031000 \*\*

50



\*\*  
RAL  
ANODIC  
AL INX  
PP

## DRACO PULL HANDLE

0310 \*\*

50



\*\*  
RAL  
AL INX

# SLIDING WINDOW

## TITAN FLUSH HANDLE

034420 \*\*

40



- \*\*
- 
- ZM INX
- PA POM
- 7 mm

## TITAN MAX FLUSH HANDLE

034700 \*\*

20



- \*\*
- 
- ZM INX
- PA POM
- 7 mm

## TITAN PULL HANDLE FOR MULTIPOINT LOCK

034600 \*\*

10



- \*\*
- 
- ZM INX
- PA POM
- 7 mm

## TITAN FLAP PULL HANDLE

034800 \*\*

10



- \*\*
- 
- ZM INX
- PA POM
- 7 mm

## MULTIPOINT 7'5 mm BACKSET

M0520

10

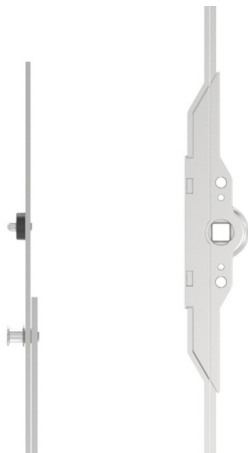

- ZM INX
- AC
- 7 mm
- 
-

# LIFT & SLIDE HANDLES

## DELTA PULL HANDLE KIT



## DELTA PULL HANDLE KIT



## DELTA PULL HANDLE WITH FINGER PULL 9.5

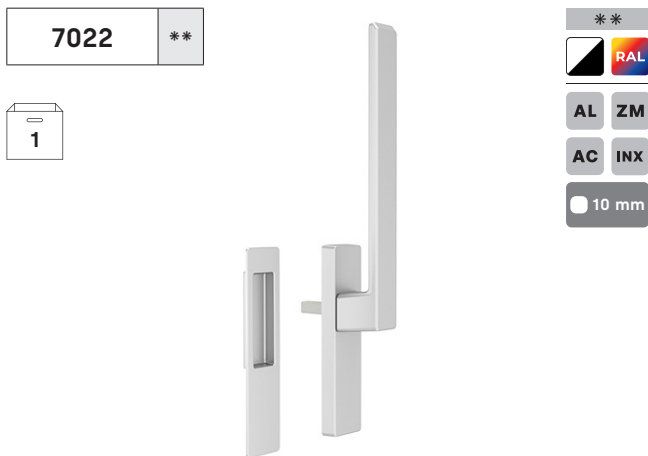

## DELTA PULL HANDLE WITH FINGER PULL 9.5



## ATRIA PULL HANDLE KIT



## ATRIA PULL HANDLE WITH FINGER PULL 9.5

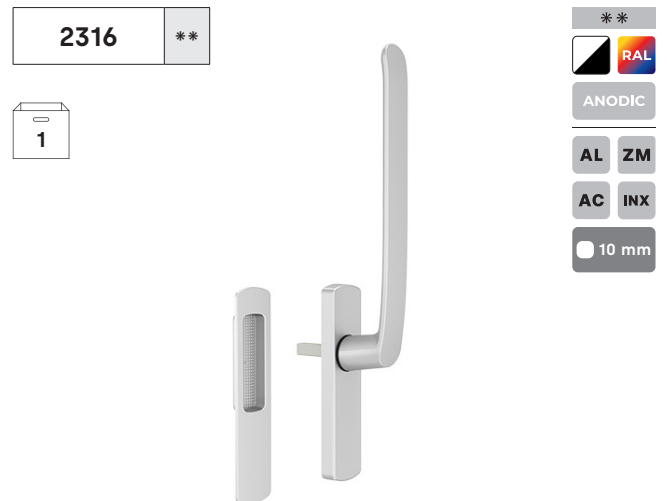

## SLIDING BOGIES

C99003 BOGIE

C99003

PA

360



C99004 BOGIE

C99004

ZM PA

120

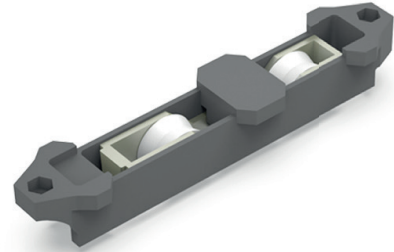

C99005 BOGIE

C99005

PA

480

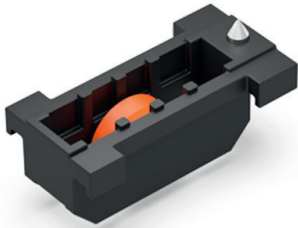

C99006 BOGIE

C99006

AL

340



C99007 BOGIE

C99007

AL

180

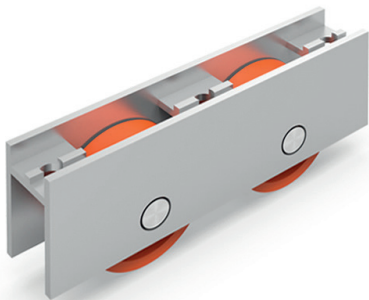



## SLIDING BOGIES

---

### C96023 BOGIE

---

96023

AC PA



### C96024 BOGIE

---

96024

ZM PA





# We are accountability

We are certified by Bureau Veritas to ISO 14001 /2018. We reuse 100% of the scraps generated in our manufacturing process, and every year we increase the percentage of raw materials with recycled origin.

We are convinced that collaborating in the design of more efficient and environmentally friendly façades and window systems is the best legacy we can leave to future generations.

## We are certified quality



FRANCE



POLAND



MEXICO



USA



SPAIN



UK



ROMANIA



SWITZERLAND



INTERNATIONAL

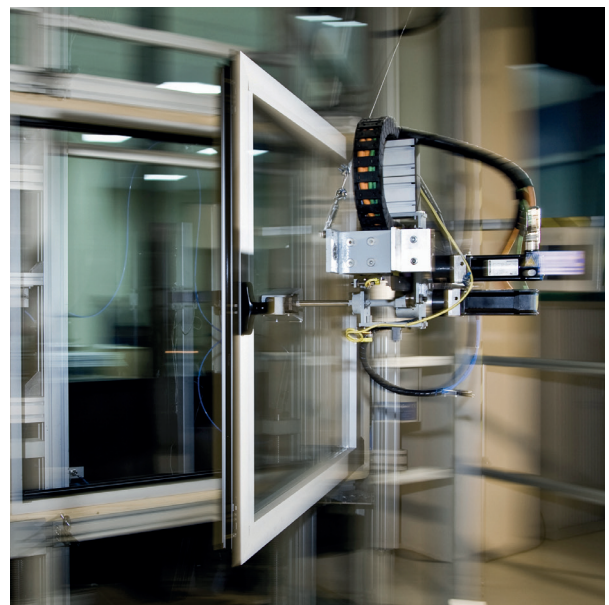
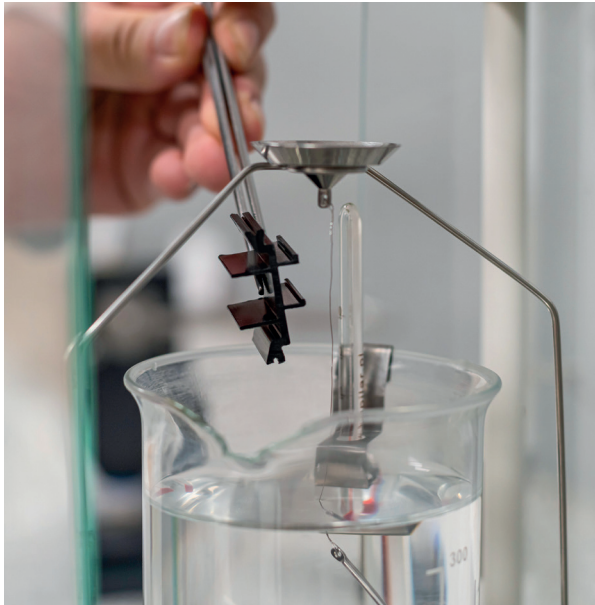

# We are close to you



## STAC Spain Headquarters

 (+34) 981 817 036

 [info@stac.es](mailto:info@stac.es)

 Aldea A Matanza s.n.  
Polígono industrial Picusa,  
15900 Padrón, A Coruña, España

**STaC**  
more than you see

[stac.es](http://stac.es)